

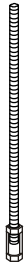

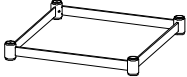





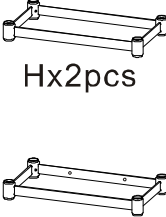

# POTTERY BARN

## MASTER ETAGERE

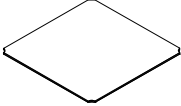
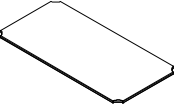
### Parts Included:

					
Ax4pcs	Bx8pcs	Cx3pcs	Dx8pcs	Ex8pcs	Fx2pcs
					 Lx2pcs
Gx2pcs	Hx2pcs H-1x1pc	 Ix4pcs	Jx3pcs	Kx3pcs	 Mx2pcs
					 Nx2pcs

### STEP 1

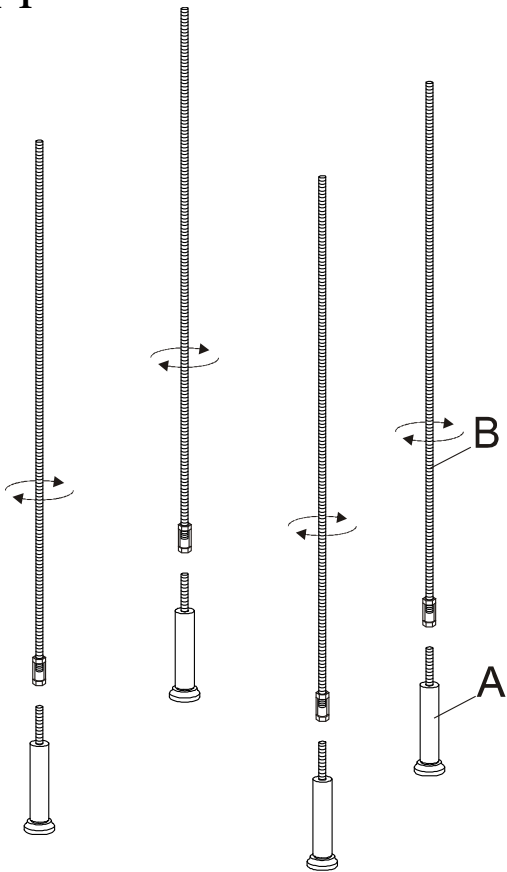

### STEP 2

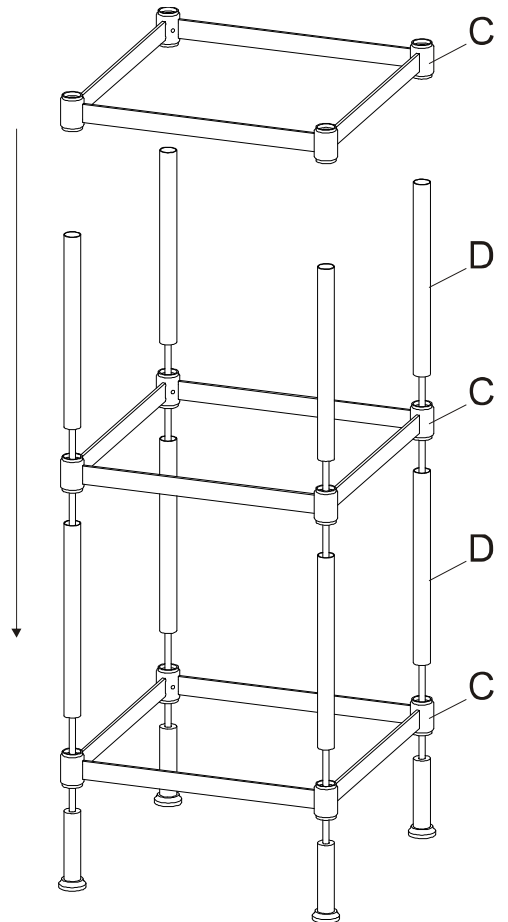

### STEP 3

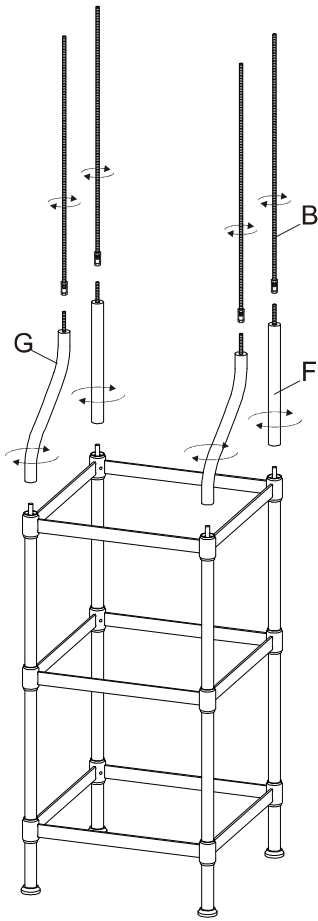

### STEP 4

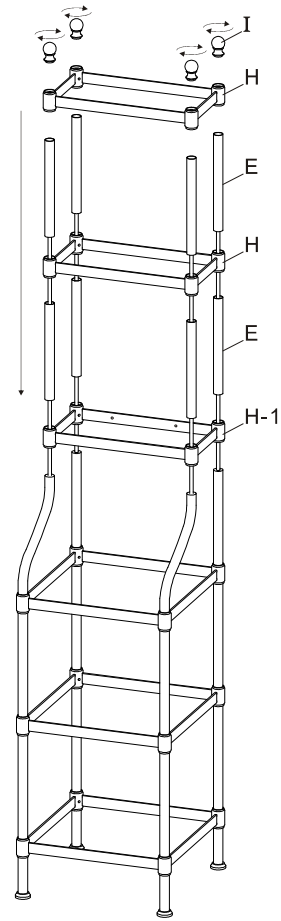

### STEP 5

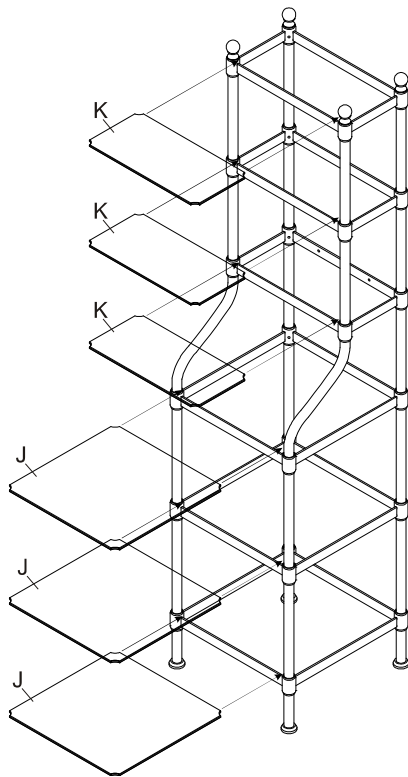

### COMPLETE

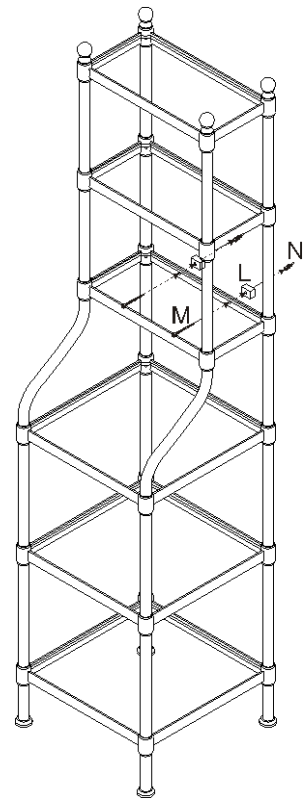

#### Care Instructions:

- Wipe with a soft, dry cloth only.
- Avoid cleaners and abrasives as they may damage the finish.

thank you for your purchase  
stores | catalog | [www.potterybarn.com](http://www.potterybarn.com)