

LINDEN DOUBLE SHELF

⚠ ENGLISH

- Do not dispose of any packaging or contents of the shipping carton until assembly is completed to avoid accidentally discarding small parts or hardware.
- Maximum total weight capacity for this product is pounds (Kg).**
- WARNING! “DO NOT MOUNT THIS ITEM ABOVE CRIBS, BEDS OR CHANGING TABLE”.**

⚠ FRANÇAIS

Ne jetez rien des produits d'emballage et du contenu de la boîte jusqu'à ce que l'assemblage soit terminé, afin d'éviter de jeter par mégarde de petites pièces ou des morceaux.

La capacité de poids total maximum pour ce produit est de livres (Kg).

ATTENTION! “NE MONTEZ PAS CET ARTICLE AU-DESSUS DE PIEDS, DE LITS OU DE TABLE À LANGER”.

⚠ ESPAÑOL

Para evitar desechar accidentalmente las partes pequeñas o las piezas de ferretería, no tirar el embalaje o contenido de la caja hasta que el ensamblaje esté completo.

La capacidad máxima de peso total para este producto es de libras (Kg).

¡ATENCIÓN! “NO MONTE ESTE ARTÍCULO SOBRE CUNAS, CAMAS O MESA PARA CAMBIAR”.

Care Instructions:

Dust often using a clean, soft, dry and lint-free cloth.

Blot spills and wipe with a clean, damp cloth immediately.

We do not recommend the use of chemical cleansers, abrasives or furniture polish on our lacquered finish.

Hardware may loosen over time. Periodically check to make sure all connections are tight. Re-tighten if necessary.

Instructions d'entretien :

Épousseter régulièrement avec un chiffon propre, doux et non pelucheux.

Éponger immédiatement les liquides renversés et essuyer à l'aide d'un chiffon propre et humide.

L'utilisation de produits nettoyants chimiques, d'abrasifs ou d'encaustiques sur nos finitions laquées n'est pas recommandée.

Le matériel de fixation peut se desserrer avec le temps. Vérifiez régulièrement afin de vous assurer que tous les raccords sont bien serrés. Resserrez-les au besoin.

Instrucciones de cuidado:

Limpiar el polvo con un trapo limpio, suave, seco y libre de pelusas.

Secar los derrames de inmediato y limpiar con un trapo limpio y húmedo.

Recomendamos no usar limpiadores químicos, abrasivos o lustramuebles sobre el acabado barnizado.

Las piezas de ferretería pueden aflojarse con el tiempo. Controlar periódicamente que estén bien ajustadas. Si es necesario, volver a ajustarlas.

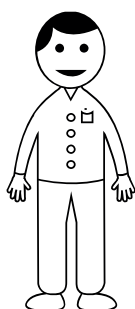

X2

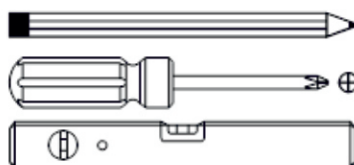

NOT INCLUDED / NON INCLUS / NO INCLUIDAS

Williams-Sonoma Inc.









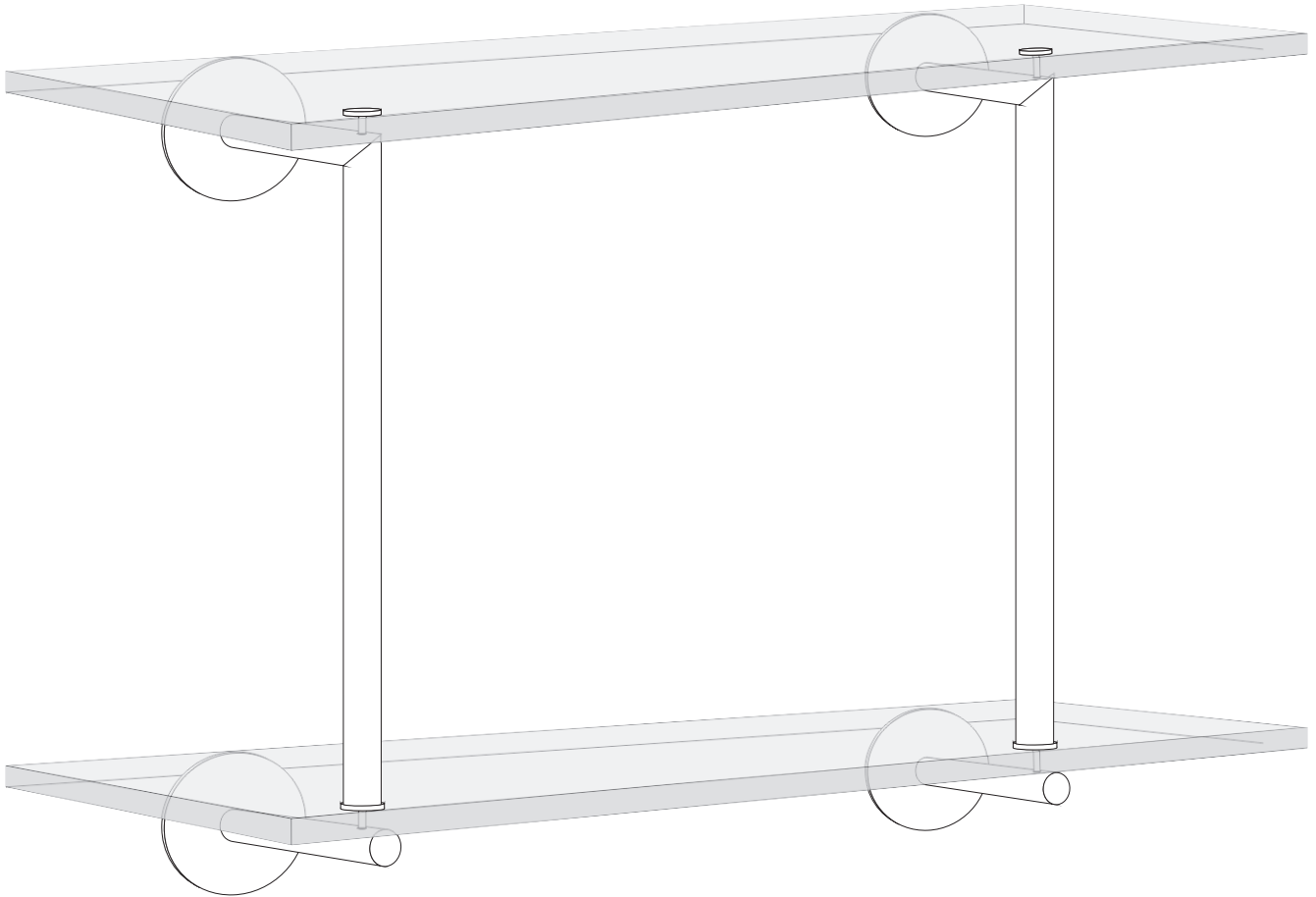

Assembly Instructions
 Instructions d'assemblage
 Instrucciones de Ensamblaje

Pottery Barn – Pottery Barn Teen – Pottery Barn Kids – Williams Sonoma Home – West Elm – Rejuvenation – Mark and Graham

01-oct-2021

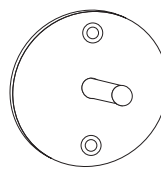
3/7

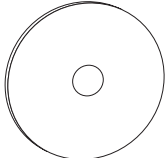

<p>A</p>  <p>8X MOUNTING ANCHOR</p>	<p>B</p>  <p>8X MOUNTING SCREW</p>	<p>C</p>  <p>2X TOP SCREW</p>	<p>D1</p>  <p>2X WASHER - SML</p>	<p>E</p>  <p>2X MOUNTING BRACKET</p>	<p>F</p>  <p>2X SHELF</p>
<p>G</p>  <p>4X MOUNTING PLATE</p>	<p>H</p>  <p>1X ALLEN KEY</p>	<p>I</p>  <p>4X HOLE WASHER</p>	<p>J</p>  <p>2X UPPER ROD</p>	<p>K</p>  <p>4X BACK PLATE</p>	

NOTE- Carefully place all the parts on floor on a smooth surface and assemble as below.

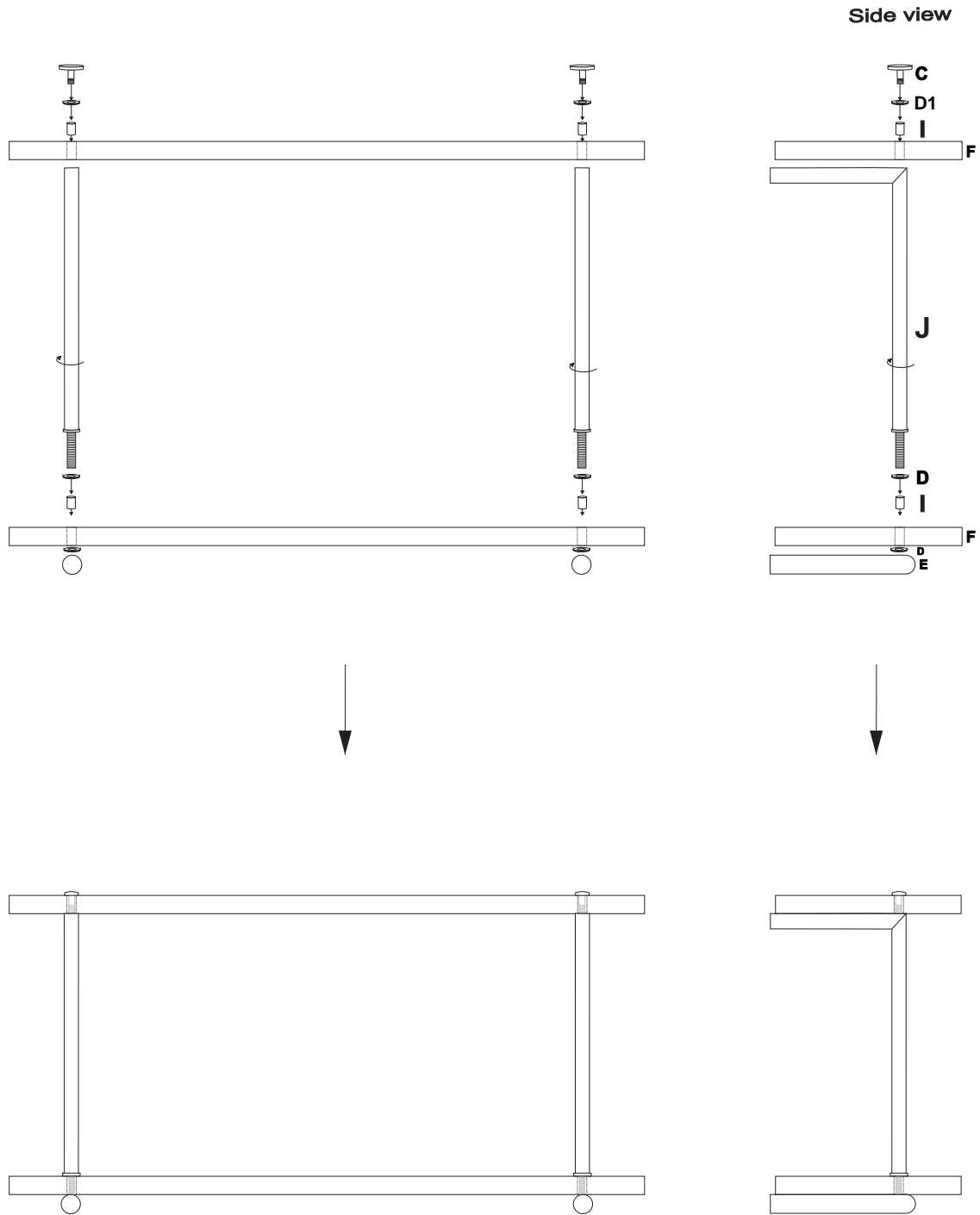

Williams-Sonoma Inc.

Assembly Instructions
Instructions d'assemblage
Instrucciones de Ensamblaje

Pottery Barn – Pottery Barn Teen – Pottery Barn Kids – Williams Sonoma Home – West Elm – Rejuvenation – Mark and Graham

01-oct-2021

5/7

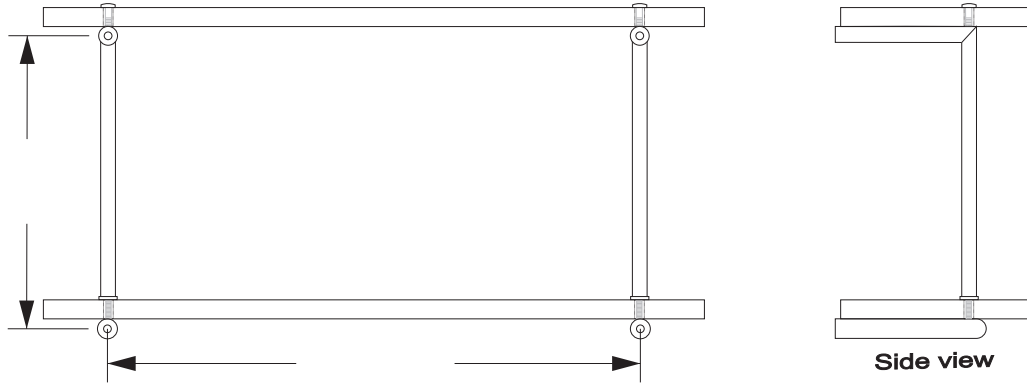

Note- Carefully measure the distance between the holes center to center horizontally and vertically and mount the mounting plates on the wall accordingly.

