

POTTERY BARN

Railway Shelf with Hooks

Mounting Instructions

This shelf has four (4) holes through which provided mounted hardware passes for wall-mounting

Max. Load: Maximum total weight capacity for this product is 20 pounds (9.06KG).

Note: Assembly by two people recommended. Open the box safely and unpack all the included items. Do not discard packing until assembly is completed.

Hardware Included: (4) Snap-screw, (4) Screws, (10) Allen Screws, (1) Allen Key

Parts Included: (2) Brackets (A & B), (5) Rods (C), (1) Large Rod, (2) Finials (E)

Tools Needed: Phillips Screwdriver, Pencil, Stud-Finder and Leveler.

Step 1: Place the Bracket (A) on the floor so that its holes align to the holes provided at the end of Rod (C), insert allen screw and rotate clockwise until tight with the help of Allen key provided.

Step 2: Now, place the second bracket at the another end of the rods such that holes align to the bracket (B) and attach them as per Step(1).

Step 3: Hold the item upright and level against both walls at a desired mounting location. Use a pencil to mark the wall through each of the four mounting holes. Set the item aside.

Step 4: The provided Snap-screw cannot penetrate wood studs. Therefore we have to determine if any of the four marks of Step (3) happens to align with a wall stud. Use a stud-finder to determine this. If any mark does align with a stud, use a screwdriver to secure a provided screw into the wall at this mark when instructed to do so below.

Step 5: For marks that do not align with a wall stud, use a screwdriver to install a provided Snap-screw into the wall at the mark. Engage the head of the Snap-screw with the screwdriver and position the Snap-screw's tip at the mark. Rotate the Snap-screw clockwise while pushing it firmly into the wall. The Snap-screw will automatically drive itself into the wall. Continue rotating until the wide end of the Snap-screw becomes even with the wall surface. Do not over-tighten.

Step 6: Now hang the shelf to the wall so that the four holes in the shelf align with either installed Snap-screw or a stud. Use a screwdriver to secure a screw through each hole and into the installed Snap-screw or stud. Rotate the screws clockwise until tight.

Step 7: Now, hold Large Rod (D) between both attached brackets as per illustration and insert Finials (E) on both ends of Large (D) and rotate clockwise until tight.

Care Instructions:

Wipe with a soft, dry cloth. Do not use any abrasive or chemical household cleaners.

Thank you for your purchase!

Stores | Catalog | www.potterybarn.com

The hardware included with this item is meant for drywall mounting only. If your wall is made from another material such as concrete or plaster, please consult your local hardware store for assistance in selecting the correct hardware.

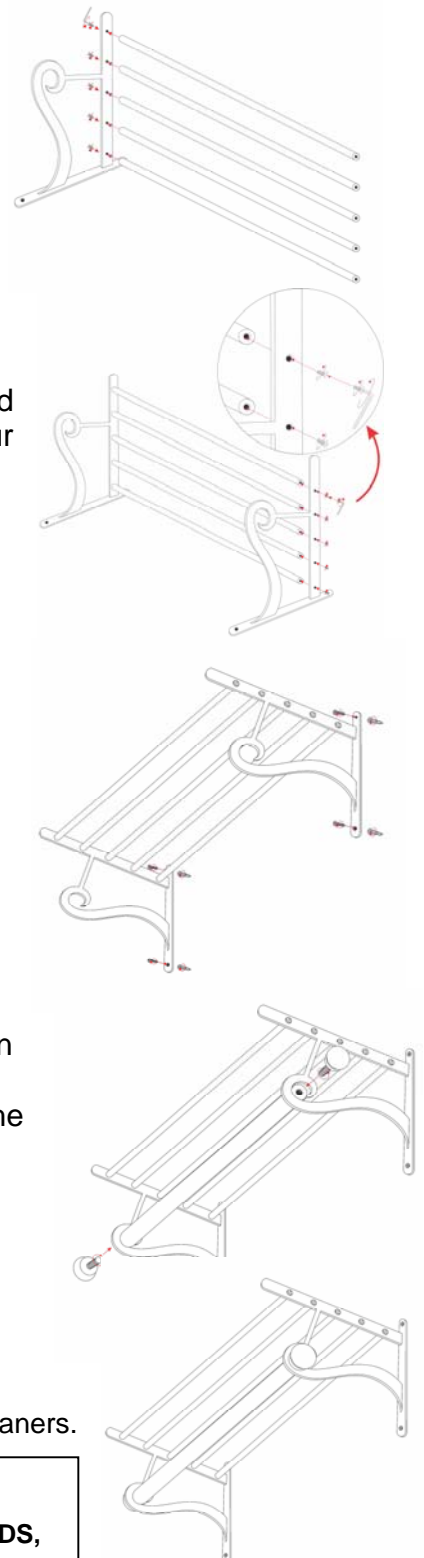

WARNING!

DO NOT MOUNT THIS ITEM ABOVE CRIBS, BEDS, or CHANGING TABLES.