

FEATURES

- ¼ turn washerless ceramic disc valve cartridges
- Flexible hose connection for 8” to 16” spread installations
- Flow rate 2.2 gpm (8.3 lpm) maximum flow rate
- Solid brass construction
- Warranty:
 - Limited lifetime warranty (residential use)
 - One year (commercial use)
- Standard finishes:
 - polished chrome
 - satin nickel
 - polished nickel
 - antique bronze
- Listed by IAPMO, CSA, NSF, and other municipalities
- Shipping weight (lbs.) 10
- Shipping dimensions (in.): 29x12x4

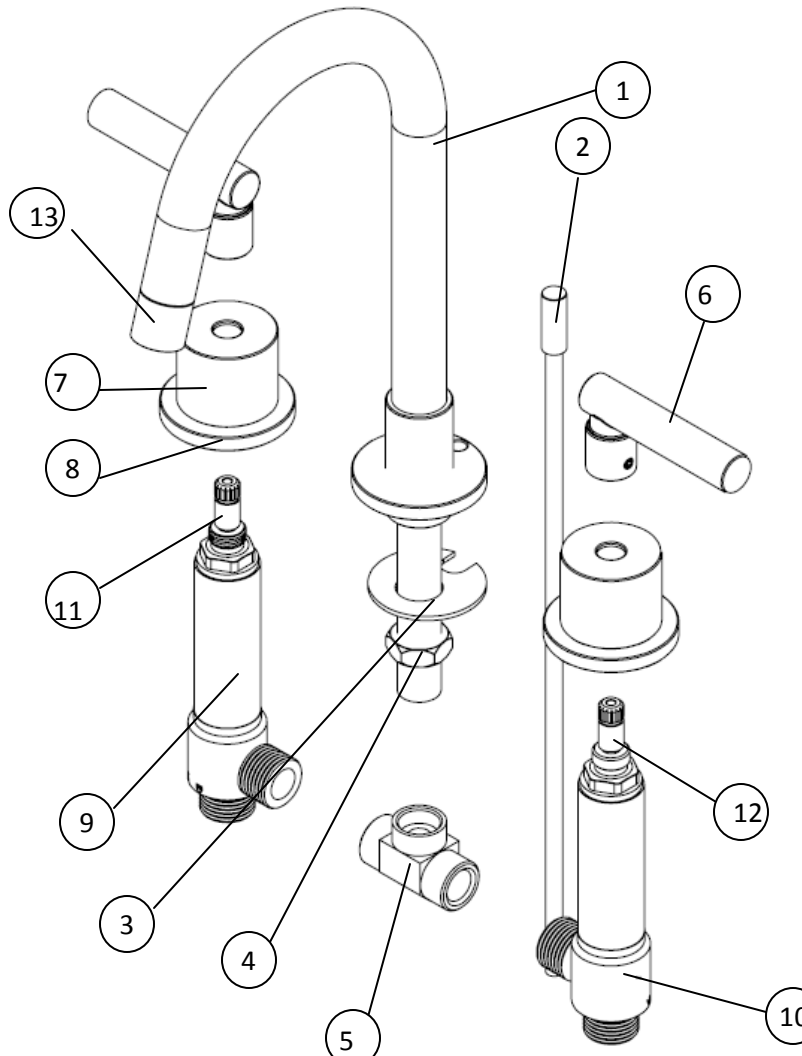

Parts Checklist		
Carefully remove all parts from the box. The following parts should be included.		
ID #	Description	Qty
1	Spout	1
2	lift knob and rod	1
3	spout washer	1
4	spout nut	1
5	spout tee	1
6	handle	2
7	escutcheon	2
8	esc. Base ring	2
9	Hot valve	1
10	cold valve	1
11	hot cartridge	1
12	cold cartridge	1
13	Aerator	1

Rev. 6/13

1. **Carefully remove all parts from the box.**
2. **Begin by first installing the Spout.**
 - a. Remove the "T" Assembly (5) and spout lock nut and washer (3,4) from the Spout (1).
 - b. Drop the Spout through the hole in your countertop or sink.
 - c. Tighten the Lock Nut and washer (3,4) against the underside of mounting surface .
 - d. Re-assemble "T" Assembly (5) onto bottom of Spout.
3. **Identify your Hot and Cold Valves.**
 - a. Remove all trim from Valve Assembly, leaving Bottom Lock Nut.
 - b. Begin to tighten the Valve (9,10) to your countertop or sink with Escutcheon and escutcheon base ring (7,8) (Refer to Diagram) but do not tighten completely.
 - c. Install Handle (6) on valve body (9,10). Be sure that bottom of handle properly clears top of the Escutcheon (7).
 - d. Once you have adjusted the Valve height, remove Handle and proceed to tighten Valve from the bottom until it is snug.
 - e. Install Handle on the Valve.
4. **Connect the two Flex Hoses to "T" Assembly (5) and to the HOT (9) and COLD (10) valves respectively. These hoses can be bent or twisted, but be careful not to kink the hoses or you will have limited water supply and excessive noise from the faucet.**
5. **Begin by bleeding the water lines before connecting to the valves. Connect water supplies to bottom of each valve.**
6. **Remove aerator (13) and flush faucet by running both Hot and Cold water in full open position. Replace the aerator.**
7. **Check for leaks. If leaks or problems occur, re-tighten all nuts before consulting a plumber.**

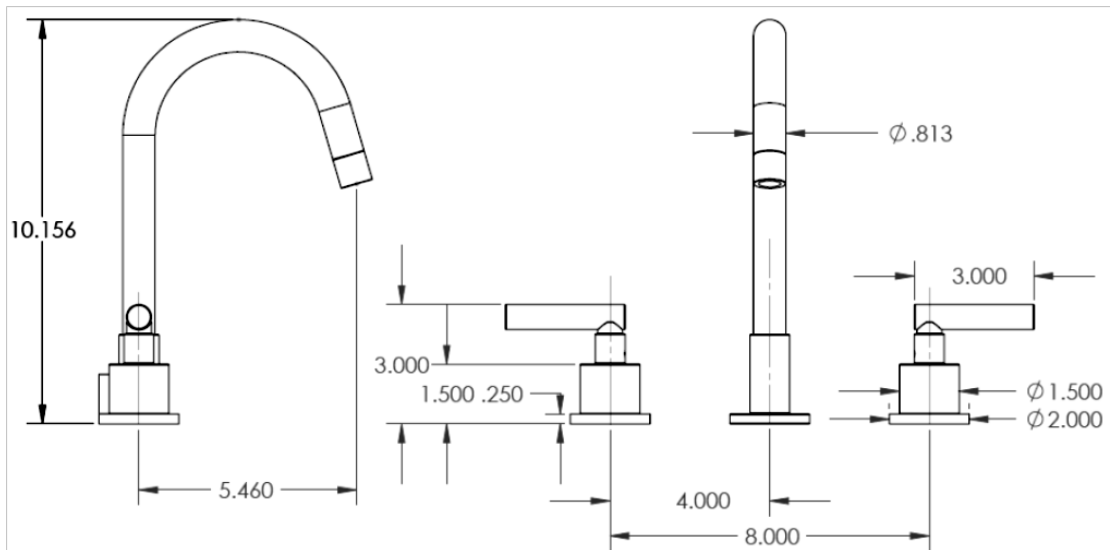

For technical support, please call 1-888-779-5176

IMPORTANT INSTALLATION INFORMATION

- USE TEFLON TAPE OR PIPE SEALANT FOR THREADED CONNECTIONS
- DO NOT USE PLUMBER'S PUTTY ON ANY OF THE BRASS COMPONENTS
This will cause the finish to tarnish and void the warranty. A non-corrosive Silicone is recommended.
- DURING SWEATING OF LINES DO NOT OVERHEAT CASTING
Overheating may cause damage to internal mechanism
- COPPER ADAPTORS MAY BE REQUIRED TO COMPLETE YOUR INSTALLATION