

# POTTERY BARN

## Welcome Stag Art Mounting Instructions

### HARDWARE INCLUDED:

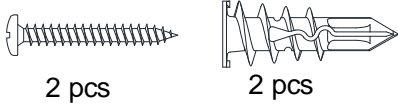

**Note:** The provided mounting hardware is meant for drywall and stud construction only. For other wall types, please consult your local hardware store for assistance in selecting the appropriate hardware.

### TOOLS NEEDED (not included):

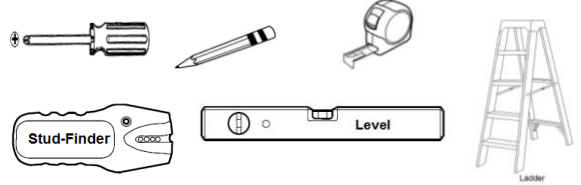

### Hanging Orientation Options:

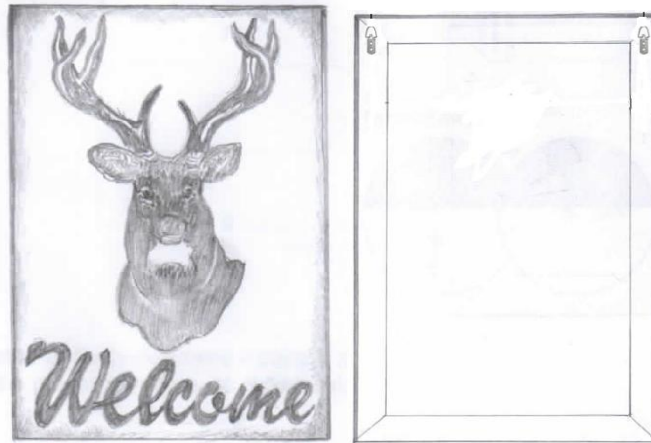

### Mounting Instructions:

**1** Measure the distance between the center of the two D-rings.



**2** With the back of the Welcome Stag Art facing away from the wall, hold it against the wall at a desired mounting location. Mark two reference points (A, B) on the wall as shown.



**3** Connect the two points (A, B) with a light pencil line. Use a level to ensure that the line is level.

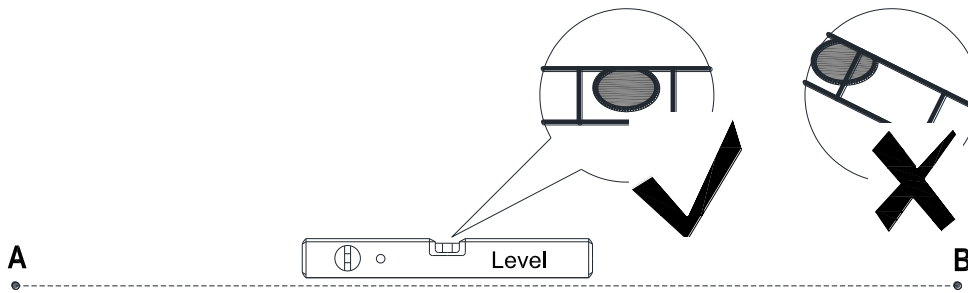

**4** Make two insertion marks (C, D) centered along the line using the measurement "a".

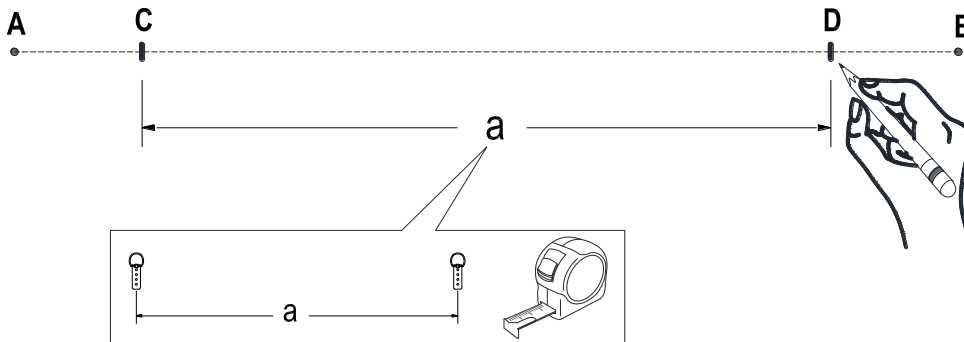

**5** Use a stud-finder to determine if there is a wall studs located at either insertion mark. Install the proper hardware, as shown below. Note that the head of each screw resides about 3/8" from the wall.



**For stud mounting:**

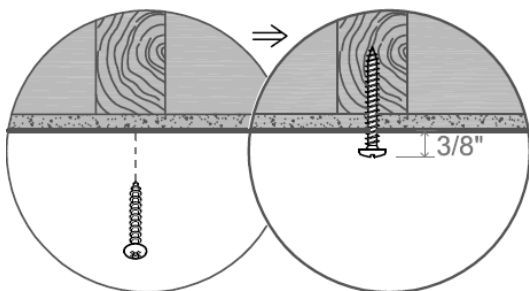

**For dry wall mounting:**

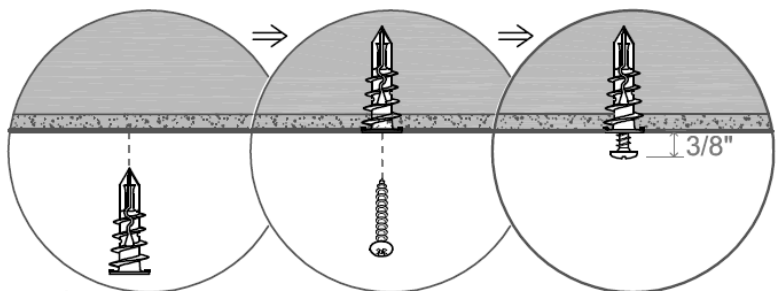

**Tips:**  
The anchor is self-drillable.  
No pilot hole required.

**6** With the help of another person, hang the Stag Art to the wall so that the D-rings engage the screw heads.



**CARE INSTRUCTIONS:**

To clean the Welcome Stag Art, wipe with a soft, dry cloth. Do not use abrasive or strong chemical household cleaners.

Thank you for your purchase!  
Stores | Catalog | [www.potterybarn.com](http://www.potterybarn.com)