

P O T T E R Y B A R N

Zoe Shadowbox

Note: The maximum load for this product is 20 lb (9.07KG).

WARNING! Do not mount this item above cribs, beds, or changing tables.

The hardware included is meant for dry wall or wood stud mounting only. If walls are concrete, brick or plaster, please consult your local hardware store for assistance.

Hardware Included:

- A. (2) Drywall Anchor
- B. (2) Mounting Screw



Drywall Anchor



Pan Head Screw

Tools Required For Mounting:

Phillips Screwdriver / Level / Pencil / Tape Measure / Stud-finder

MOUNTING INSTRUCTIONS:

This product includes two pairs of keyhole plates on the back for wall mounting in either a portrait or landscape orientation. (The square size shadowbox includes only one pair of keyholes)

1. Hold the shadowbox upright against the wall at a desired location. Use a level to ensure the item is not tilting and then use a pencil to mark on the wall along the entire top of the shadowbox. This mark will be a reference to determine the location of the mounting hardware.
2. Measure the distance from the top edge of the shadowbox to the upper center of both keyholes' narrow slots. Return to the wall and measure these distances down from the horizontal line made in Step #1 to mark a new horizontal line.
3. Return to the shadowbox and measure the distance between the two keyholes (measure from center to center of each keyhole). Use this measurement to make two points centered along the line made in Step #2. These are the insertion points for your mounting hardware.
4. Use a stud-finder to see if either insertion mark happens to align with a wall stud or not. If a mark does align, use a Phillips screwdriver to secure a screw directly into the wall at that mark, leave the screw head about 3/8 inch protruding from the wall.
5. For marks that do not align studs, first install an anchor into the wall. Place a Phillips screwdriver into the recess of an anchor and then position it over one of the insertion point marks. Do not "pound" the anchor; it is designed to bore into the wall like a drill bit. Slowly turn the anchor clockwise while applying even pressure until the anchor's head is flush with the wall. Repeat for the other anchor if needed. (Fig.1)
6. Insert a screw into each installed anchor and use the screwdriver to rotate it clockwise until the screw head is about 3/8 inch from the wall. (Fig.2)
7. Mount the shadowbox by fitting the large opening on each keyhole over the screw heads. Push the item down so that the screw heads slid up the keyholes' narrow slots and lock it into place. You may need to tighten or loosen the screws to allow the item to fit snugly against the wall. (Fig.3)

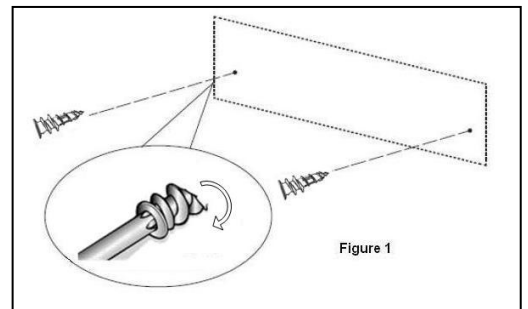

Figure 1

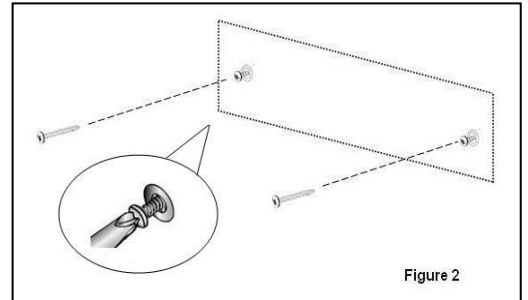

Figure 2

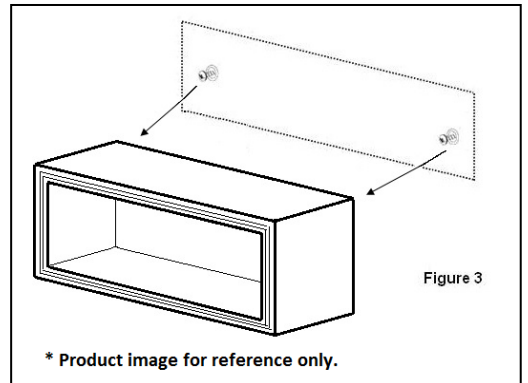

Figure 3

* Product image for reference only.

CARE INSTRUCTIONS:

Wipe with a soft, dry or slightly damp cloth. To protect the finish, do not apply household cleaners or abrasives.

Thank you for your purchase

www.potterybarn.com

USA 800.922.9934