

P O T T E R Y B A R N

Classic Wall Storage

Assembly Instructions

Important Safety Instructions:

- Please read all instructions carefully before assembling. For your safety, assembly by two people is recommended.
- This hanging system is meant for drywall/stud mounting only. If walls are concrete, brick or plaster, please consult your local hardware store for assistance.
- When mounting to a stud use only wood screws.
- The maximum individual shelf weight capacity is 20lbs. Do not exceed the load capacity.









Parts Included:

- (A) Cabinet (1pc)
- (B) Glass Shelf (2pcs)

Tools required (not included):

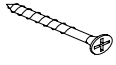
- Phillips Head Screwdriver
- Pencil
- Stud Finder
- Felt Tipped Pen

Hardware Included:

- | | | | | |
|---|---|---|--|---|
|  |  |  |  |  |
| (C) Plastic Plug (1pc) | (D) L-Shape Peg (8pcs) | (E) Wall Bracket (1pc) | (F) Toggle (2pcs) | (G) Toggle Screw (2pcs) |
|  |  |  |  |  |
| (H) Stud Screw (1pc) | (I) Level (1pc) | (J) Anchor (1pc) | (K) Anchor Screw (1pc) | (L) Rubber Sheet (2pcs) |

Pre-Assembly:

- Remove all parts and hardware from the box and lay out on a clear workspace, along with any plastic protective packaging. Do not dispose of any contents until assembly is complete to avoid accidentally discarding small parts or hardware.
- Use the parts and hardware lists above to identify and separate each of the pieces included.
- The illustrations provided allow for easier assembly when used in conjunction with the assembly instructions.
- Keep all parts and plastic bags out of the reach of children.

INSTALLATION SUMMARY: FIND WALL STUDS, MOUNT WALL BRACKET TO THE WALL, HANG PRODUCT ONTO THE MOUNTED WALL BRACKET

FIND WALL STUDS:

- Determine the desired placement on the wall for the product. Within that range, locate a stud using a stud finder and make a small mark on the wall with a pencil at that location.
- It is best to mount the bracket to at least (1) stud. Using Figure 1, determine which hole on the wall bracket will be over the stud, this hole will take a wood screw alone.

MOUNT WALL BRACKET TO THE WALL

1. Insert the supplied bubble level (I) into the channel of the wall bracket (E). Position the wall bracket (E) on the wall and adjust so that the bracket is level and a pre-drilled hole of the bracket aligns with a stud. Then, use a felt-tipped pen to mark the wall through appropriate pre-drilled holes of the bracket to indicate the locations of the drywall toggles (F). Also make sure to mark the bracket itself at each selected pre-drilled hole using the pen. (Please refer to Figure 1 to determine the location of the hardware.) The locations of the drywall toggles will depend on how the stud aligns with the bracket. The user should make sure that the stud and the toggles are evenly spaced along the length of the bracket and that the ends of the bracket should be secured using either a stud-mounted screw or a drywall toggle.
2. Remove the wall mount bracket and set aside.
3. Using a manual screwdriver, drive a toggle (F) into the drywall at each mark. To install these toggles into the wall, simply rotate them at the marked location as if they were a large screw, applying smooth even force. **DO NOT HIT THEM WITH A HAMMER AND DO NOT USE A POWER DRILL TO ROTATE THEM.** These toggles are designed to bore themselves into the wall. Continue rotating until the toggle head advances flush with the wall surface.
4. Once the toggles (F) are installed into the wall at the marked locations, reposition the wall bracket so that the marked holes of the bracket align with the toggles. Using the supplied toggle screw (G) secure the bracket to the installed toggles. Note: The toggle includes a nut portion that must be "set" into a locked position prior to using the product. This is done automatically as you rotate the toggle screw into the toggle, but keep in mind that the screw must be rotated quite a few times before the nut finally reaches this locked position. The nut will create resistance when it reaches the locked position within the wall.

- Once the wall bracket (E) is attached to each toggle (F) using the toggle screw (G), the bracket must be secured to the stud located along the bracket. Use the supplied stud mount screw (H) to secure the wall bracket to the stud (note, a pre-drilled hole of the bracket should align with the stud location).

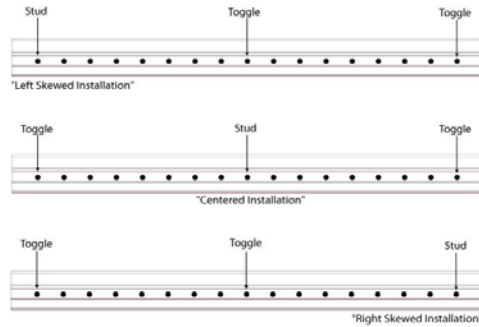
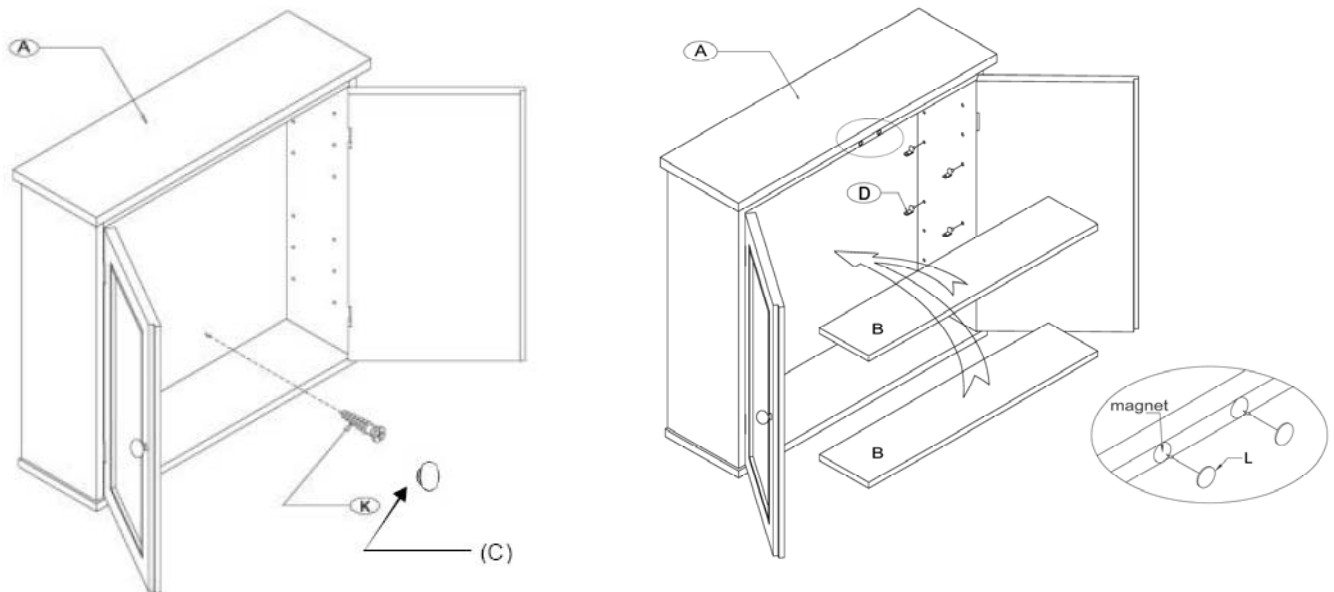

Figure 1 bracket

HANG THE PRODUCT ONTO THE MOUNTED WALL BRACKET

- On the back of your product is an affixed product-mounting bracket.
- With the help of another person, carefully position the product-mounting bracket slightly above and against the wall mount bracket, insuring that the two brackets are aligned. Engage the brackets.
- With a pencil, mark on the wall through the location of the lower mounting point.
- Remove the cabinet. Use the marked point as the insertion point for the anchor (J). Place the Philips Head Screwdriver into recess of the anchor. Slowly turn the anchor clockwise while applying pressure until the flange just touches the wall.
- Again, carefully position the product-mounting bracket slightly above and against the wall mount bracket, insuring that the two brackets are aligned.
- Press down firmly to engage the two brackets.
- Insert the anchor screw (K) through the pre-drilled hole inside the cabinet. Tighten against wall. Cover the screw head with plastic plug (C).



Shelf Installation:

Insert the L-shape Peg (D) into the pre-drilled holes on the interior side of the Cabinet (A) at desired level. Carefully insert the Glass Shelves (B) into the cabinet. Gently rest the shelves onto the shelf pegs.

Optional: Attach the Rubber Sheet (L) into the magnet in the cabinet.

Care Instructions:

- Wipe cabinet with a soft, dry cloth.
- To protect the finish, avoid the use of all chemical and household cleaners and abrasives as they may damage finish.

thank you for your purchase
stores/catalog/www.potterybarn.com