

P O T T E R Y B A R N

SOMERSON SCONCE

Important Safety Instructions:

- These instructions are provided for your safety. It is important that they are read carefully and completely before installing fixture.
- We strongly recommend that a professional electrician install all direct wire fixtures.
- This fixture has been rated for up to (3) 100-watt maximum bulb (not included). To avoid the risk of fire, do not exceed the recommended wattage.
- Not intended for outdoor use.

Parts Included:

- (1) Light Fixture (A)
- (3) Glass Shades (B)
- (1) Mounting Plate (C)

Hardware Enclosed:

- (2) 7mm x 33mm Mounting Screws (d)
- (2) 10mm x 20mm Plastic Wire Nuts (e)
- (2) 7mm x 10mm Side mount screws (f)
- (3) Screw collars (g)

Tools Required for Assembly:

- Electrical tape
- Screwdriver
- (2) outlet box screws (usually supplied with outlet box)

Pre-assembly:

- Remove all parts and hardware from box along with any plastic protective packaging. Do not discard any contents until after assembly is complete to avoid accidentally discarding small parts or hardware.

1. SHUT OFF THE MAIN ELECTRICAL SUPPLY FROM THE MAIN FUSE BOX/CIRCUIT BREAKER
2. Gently pull the wiring out from the outlet box in your home and allow wires to hang.
3. Place the flat side of the mounting plate (C) flush with the outlet box. Gently pull the wiring from the outlet box through the mounting plate and allow wires to hang. Position the mounting holes in the mounting plate with the corresponding holes in your outlet box. Insert mounting screws (d) through the mounting plate and outlet box. Tighten with a screwdriver.
4. IT IS IMPERATIVE THAT THE OUTLET BOX IS PROPERLY GROUNDED. Attach the outlet box GROUND WIRE (green or bare wire) to the bare copper GROUND WIRE of the fixture. Fasten with a plastic wire connector (e) and wrap with electrical tape.
5. If there is no ground wire from the junction box, connect a ground wire (copper) to the mounting bar with the green screw provided. Make sure all wire connectors are screwed on securely and do not easily pull off the wires.
6. Carefully inspect the sconce's two fixture wires. One is white (neutral) the other is black (hot).
7. Connect the NEUTRAL WIRE from the fixture to the NEUTRAL WIRE in the outlet box (usually white). Fasten together with a plastic wire connector (e) and wrap the connection with electrical tape. Be sure that no wire strands are exposed.
8. Connect the HOT WIRE from the fixture to the HOT JUNCTION BOX WIRE in the outlet box (usually black). Fasten together with a plastic wire connector (e) and wrap the connection with electrical tape. Be sure that no wire strands are exposed.
9. Tuck the wire connections neatly into the outlet box.
10. Position the back plate of the fixture (A) over the mounting plate making sure that all wire connections are tucked neatly behind the back plate.
11. Using screwdriver, secure fixture (A) to mounting plate with side mount screws (f).
12. Place the top of the glass shade (B) into the socket cup. Secure the glass by turning the screw collar (g) around the socket in a counter-clockwise direction until a snug fit is achieved.
13. Insert bulbs (not included) and restore power to the junction box.
14. Installation is complete.

Care Instructions:

- Wipe with soft dry cloth only.
- Always avoid the use of harsh chemicals or abrasives.

thank you for your purchase

stores | catalog | www.potterybarn.com

2,3

JUNCTION BOX

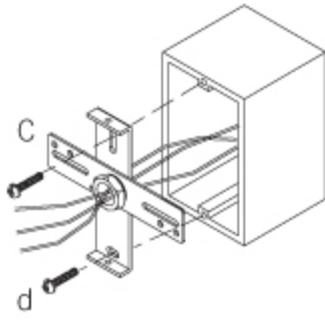

4,5,6,7,8

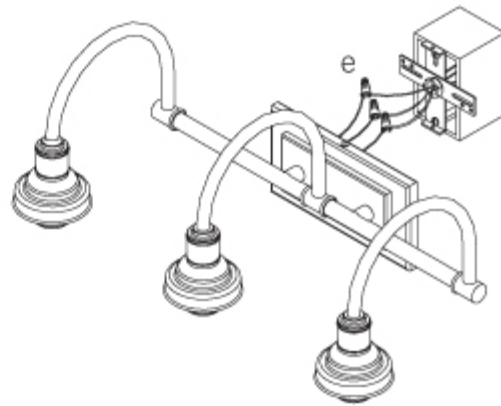

9,10,11

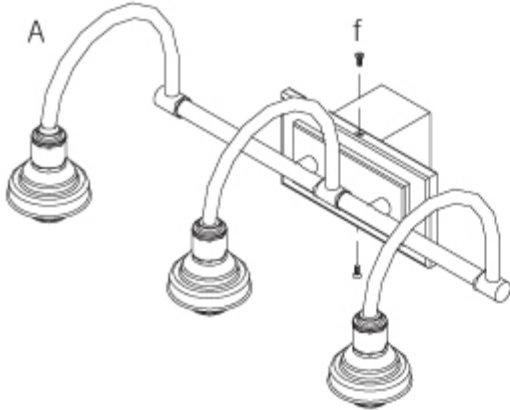

12,13

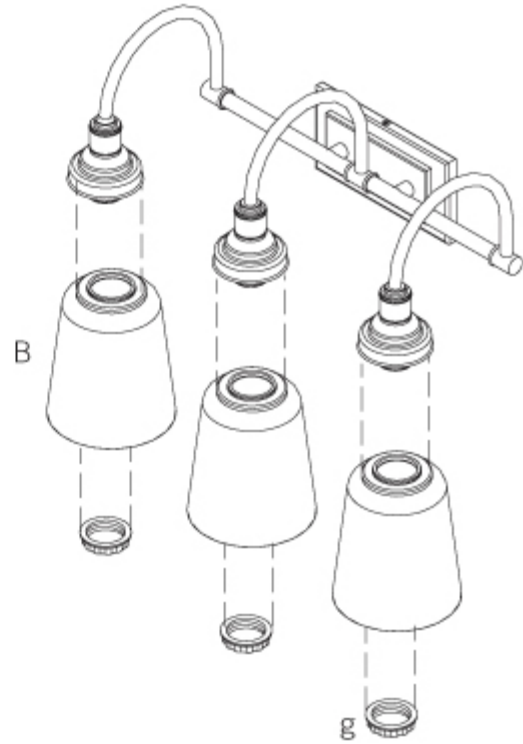

14

