

# P O T T E R Y B A R N

## Double Cabinet Wall Art

### Mounting Instructions

### Hardware:

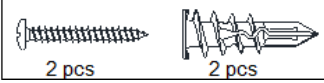

The hardware included with this item is meant for dry wall or stud mounting only. If your walls are made from concrete, brick or plaster, please consult your local hardware store for assistance in selecting the appropriate hardware.

### Hanging Orientation Options:



### Mounting Instruction:

**1** Measure the distance between the center of the two keyholes.



**2** With the back of the Double Wall Cabinet facing away from the wall, hold it against the wall at a desired mounting location. Mark two reference points (A, B) on the wall as shown.



### TOOLS NEEDED (not included):

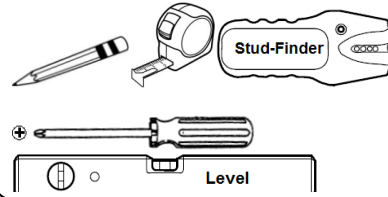

**3** Connect the two points (A, B) with a light pencil line. Use a level to ensure that the line is level.

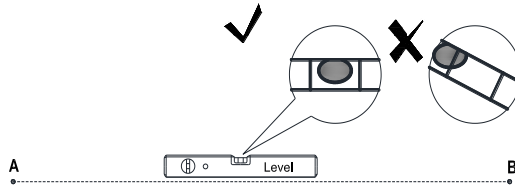

**4** Make two insertion marks (C, D) centered along the line using the measurement "a".

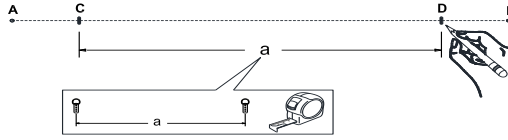

**5** Use a stud-finder to determine if there is a wall stud[s] located at [each] either insertion mark. Install the proper hardware, as shown below. Note that the head of each screw resides about 3/8" from the wall.

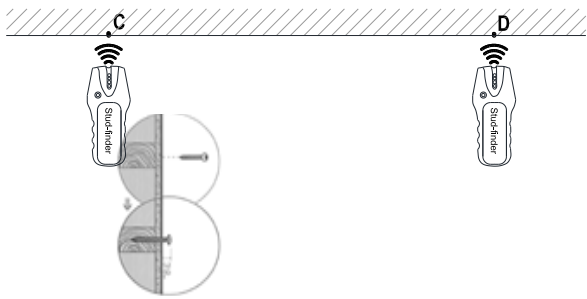

Stud Mounting

Dry Wall Mounting

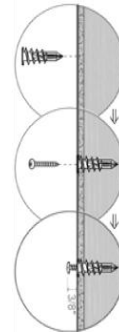

**6** With the help of another person, hang the item to the wall so that the keyholes engage the screw heads.

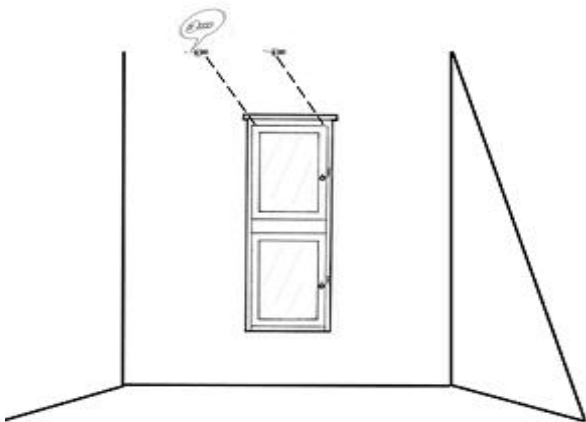

**Care Instructions:**

- Dust often with a soft, dry cloth
- Avoid using strong chemical or abrasive cleaners.

Thank you for your purchase  
[Stores/catalog/www/potterybarn.com](http://Stores/catalog/www/potterybarn.com)